

Troop 1292 # 86A

MERIT BADGE SERIES



# PLUMBING



BOY SCOUTS OF AMERICA®

# PLUMBING



## HOW TO USE THIS PAMPHLET

The secret to successfully earning a merit badge is for you to use both the pamphlet and the suggestions of your counselor.

Your counselor can be as important to you as a coach is to an athlete. Use all of the resources your counselor can make available to you.

This may be the best chance you will have to learn about this particular subject. Make it count.

If you or your counselor feels that any information in this pamphlet is incorrect, please let us know. Please state your source of information.

Merit badge pamphlets are reprinted annually and requirements updated regularly. Your suggestions for improvement are welcome.

Send comments along with a brief statement about yourself to Youth Development, S209 • Boy Scouts of America • 1325 West Walnut Hill Lane • P.O. Box 152079 • Irving, TX 75015-2079.

## WHO PAYS FOR THIS PAMPHLET?

This merit badge pamphlet is one in a series of more than 100 covering all kinds of hobby and career subjects. It is made available for you to buy as a service of the national and local councils, Boy Scouts of America. The costs of the development, writing, and editing of the merit badge pamphlets are paid for by the Boy Scouts of America in order to bring you the best book at a reasonable price.

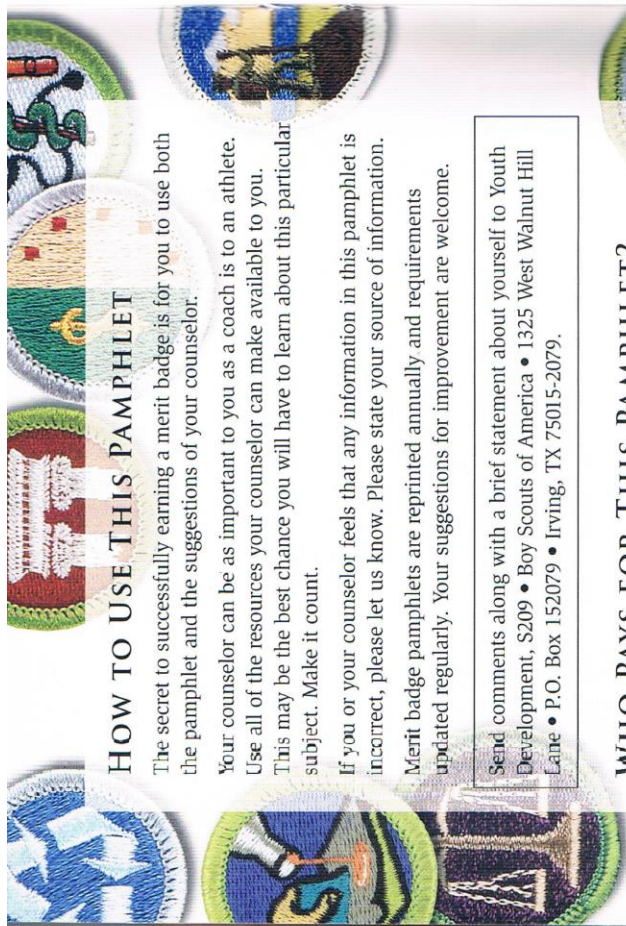

## Requirements

1. Do the following:
    - a. Describe how a properly working plumbing system protects your family's health and safety.
    - b. List five important local health regulations related to plumbing and tell how they protect health and safety.
    - c. Describe the safety precautions you must take when making home plumbing repairs.
  2. Do the following:
    - a. Make a drawing and explain how a home hot- and cold-water supply system works. Tell how you would make it safe from freezing.
    - b. Make a drawing and explain the drainage system of the plumbing in a house. Show and explain the use of drains and vents.
  3. Show how to use five important plumber's tools.
  4. Identify and describe the use of each of the following: washer, retaining nut, plunger (rubber force cup), solder, flux, elbow, tee, nipple, coupling, plug, union, trap, drainpipe, and water meter.
  5. Name the kinds of pipe that are used most often in a plumbing system. Explain why these pipes are used.
  6. Cut, thread, and connect two pieces of steel pipe.
7. Under the supervision of a knowledgeable adult, solder three copper tube connections using a gas torch. Include one tee, two straight pieces, and one coupling.
  8. Do the following:
    - a. Replace a washer in a faucet.
    - b. Clean out a sink or lavatory trap.



## Contents

Introduction . . . . .	7
The Plumbing System of a House . . . . .	8
Health and Safety Issues . . . . .	19
Plumber's Tools and Their Uses . . . . .	22
Pipes and Fittings . . . . .	27
Working With Pipe . . . . .	30
Soldering Copper Pipe . . . . .	35
Home Plumbing Repairs . . . . .	38
Plumbing Resources . . . . .	48

## Introduction

Plumbing, including pipe fitting, is an important and well-paid occupation. The industry is quite broad. It covers installations and repairs in homes, commercial properties, and factories. Plumbing pipelines are used for water supply, waste drainage, natural-gas heating, and many other purposes.

As a Scout, your major interest in plumbing probably will be in the field of home repairs. If a faucet leaks, a pipe freezes, or a plumbing fixture does not operate properly, you will want to know how to evaluate the problem. Then you will be able to decide on the proper steps to take to fix the problem—or determine that the job requires a professional plumber.

When you discover a plumbing problem, you can often take care of basic plumbing needs, but remember that a plumber is like a doctor. For serious trouble or problems beyond your ability, you should get help from a trained specialist.

As you try out the projects and fulfill requirements for the Plumbing merit badge, you will develop many practical skills. Even if you do not make plumbing your vocation, this experience will help you gain knowledge that will always be useful.



# The Plumbing System of a House

The plumbing system of a house relies on two basic things: pressure and gravity. When you turn on a faucet, you can feel the water pressure, weak or strong. The pressure comes from a pump (if the water comes from a well) or from gravity (if the water comes from a water tower or reservoir). When you flush a toilet or pull the plug from a bathtub, gravity pulls the waste and water down and away from the house.

A home's plumbing can be divided into two main systems: the supply system and the drainage system.

## The Supply System

The supply system brings clean water into a home. The water may come from a private well or from a municipal (city) source. If you get your water from a municipal source, a large pipe called a water main runs near your house. Between the main and your home is a water meter, which keeps track of the amount of water you use. If you use a private well, you do not have a meter.

Close to the meter are one or two shutoff valves you can use to stop the water to your home. If there are two valves to choose from, use the one that supplies the water to your meter instead of the one between the meter and your house. This practice will help keep the meter from being damaged by water pressure.

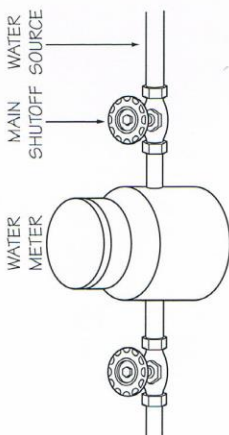

The house water main

It is important to know how to shut off the water supply to your home in case of an emergency. Because supply water is always under pressure, if a leak or break occurs, water will flow out of the pipe or broken appliance. For this reason, it is important to shut off the water supply so flooding does not occur.



Direct water meter

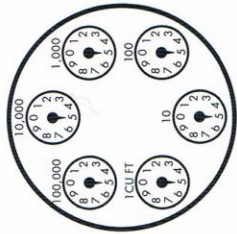

Dial water meter

Two kinds of water meters are "dial" and "direct." To read the meters, all you have to do is a little subtraction. If you have a dial meter, write down the positions of the pointers. After a few days, write down the new positions. Subtract the first reading from the second to determine how much water was used in gallons or cubic feet. If you have a direct meter, simply write down the number, wait a few days, and then subtract it from the new number.

Keep in mind that there are lots of smaller shutoff valves throughout your home. If one of your water pipes breaks, or if the smaller shutoff valves do not work properly, you will need to use the main shutoff valve.

The water enters your house through the service pipe. Inside your house, the service pipe branches off to supply cold water to fixtures and appliances, including the hot-water heater. From the hot-water heater, pipes branch off to supply hot water to the places it is needed, such as sinks, bathtubs, and washing machines.

Another place to stop the main water supply to your house is at a valve box. If you have one, it will be under a round metal cover in the ground. You may need a long-handled "key" to turn the valve, or you may be able to turn it by hand.

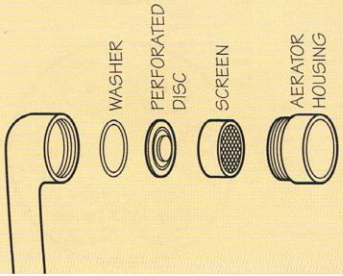

Turning the water supply off and on some-times makes pipes vibrate and “knock.” This happens because there are air pockets in the pipes. In older pipes, mineral deposits can be knocked loose, causing faucet aerators to clog. Fortunately, aerators are easy to clear. Take apart the aerator, soak the parts in vinegar, and then brush them with an old toothbrush. Put the aerator back together, making sure the washer is in good shape and makes a tight seal.

**Assembling faucet attachments**

Water for household use can be heated by a number of means: an automatic gas heater, an automatic electric heater, an oil- or gas-fired boiler that takes advantage of the furnace burner, or a solar heater that uses solar collectors on the roof.

In general, gas or electric water heaters and boiler systems work this way. When the water temperature falls below the temperature set on the thermostat, the heater automatically turns on. It runs until the desired water temperature is reached and then shuts off. A pipe at the top of the hot-water heater distributes the heated water through the hot-water pipes in a home.

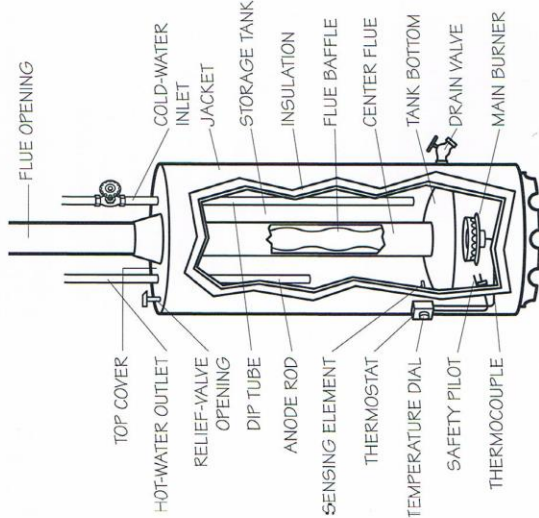

**Sectional view of an automatic gas storage tank water heater**

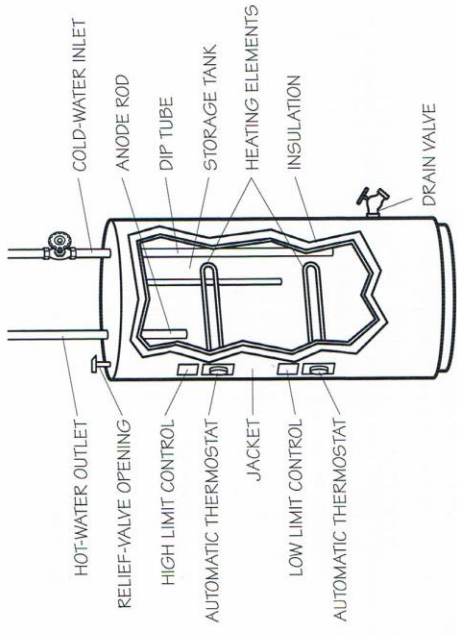

**Sectional view of an automatic electric storage tank water heater**

The American National Standards Institute (ANSI) now requires a new safety feature in residential gas-fired water heaters. The flammable vapor ignition resistant (FVIR) units feature a one-way air intake system and *flame arrestor plate*, which prevent heated air and flammable vapors from re-entering the room once they have entered the heater's combustion chamber. Flammable vapors are contained within the heater, helping to keep the surrounding area safe.

**Flammable vapor ignition resistant (FVIR) water heater**

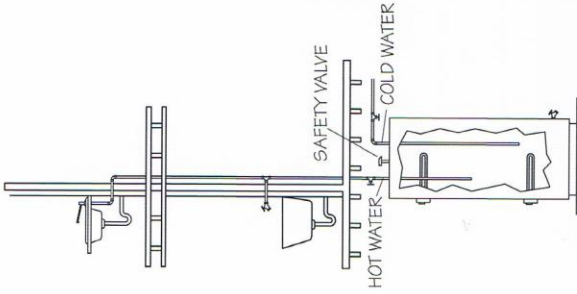

Electric water heater

A solar system uses a storage tank. A pressure pump pushes water through the rooftop solar collectors to the storage tank until the water is heated. Usually a gas or electric water heater is used as a backup for cloudy days.

Water expands when it is heated. If it gets hot enough, it will form steam. The exact temperature at which water turns to steam depends upon the pressure. All hot-water heating systems have temperature and pressure-relief valves that allow for this expansion and the escape of steam. A properly working valve will prevent explosions.

At least once each year, a knowledgeable adult should shut off the power and water and drain the hot-water heater to remove sediment that collects in the bottom of the tank. Such sediment can prevent your relief valves and thermostats from working correctly. If the relief valve leaks or overflows, call a plumber to fix it. **Do not simply plug it. You need that valve to protect your home from fire and explosions.**

### The Drainage System

The drainage system uses gravity to carry waste and water away from your home. Drainpipes run vertically or slope downward. They are larger in diameter than supply pipes and have gentle bends so that waste can move freely. The drainage system includes cleanouts and traps—places that clogs can be cleared, usually with a “snake,” or an auger.

Your home’s “waste stack” is vertical and usually 3 or 4 inches in diameter. Toilets must drain directly into the waste stack. Sinks and bathtubs may use branch pipes that slant downward into the waste stack at no less than 1/4” per foot (see the illustration shown). The waste stack connects to the main house drain, which usually is just beneath the basement floor or in the crawl space under your house. It runs at a downward slope to the septic system or to a sewer main (a city pipe that carries waste and water to a treatment plant).



It is very dangerous to plug a relief valve. If it needs to be fixed or replaced, call a plumber.

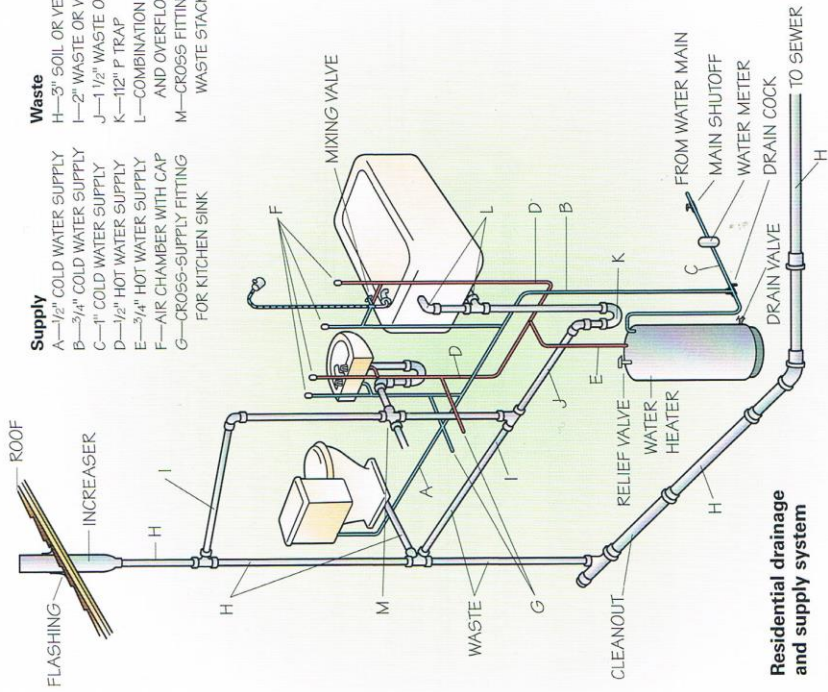

Residential drainage and supply system

### Vents

Plumbing systems must have air vents to allow the free passage of waste from fixtures. The air vents are an important part of waste disposal, which is why the drainage system is often called the drain-waste-vent (DWV) system. The drain and vent pipes are tied together, or share pipes, and use the same types of pipe.

As you can see in the illustration showing the drainage and supply system, the main vent is an extension of the soil pipe. Without air vents, the plumbing system would become air-bound, like a small-necked bottle filled with water and then



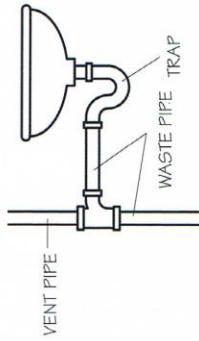

**Vent connection for vertical waste pipe**

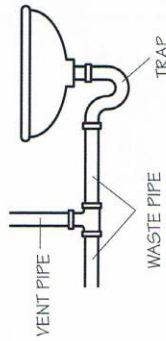

**Vent connector for horizontal waste pipe**

turned upside down. The water would run out of the bottle very noisily, and it would take the bottle a long time to empty. However, if a hole the size of the bottleneck were made in the bottom of the bottle, the water would readily escape when the bottle was tipped. For the same reasons, it is necessary to vent the plumbing at the proper places and with the proper size of pipe.

Vent pipes allow fresh air to pass freely throughout the plumbing system and to prevent loss of water from traps due to *siphoning* (suction caused by a volume of water that has just passed through or near the trap).

Vents also allow sewer gas to pass out safely above the level of open windows and people. Sewer gas is poisonous. It also can cause explosions.

**Traps**

Under every plumbing fixture there is a bent piece of pipe or special fitting that is known as a *trap*. (A toilet has a built-in trap.) Traps come in the shape of a drum (in older installations), or a J, S, or P. Water rests in the trap and is called a water seal. The water seal permits liquids and solids, but not air, to pass through the pipe. As a result, any drain air or sewer gas that might gather in the drainage system cannot make its way into your home. Every time water travels down the drain, new water replaces it in the trap, forming another seal.

If the water in a trap escapes, toxic and explosive sewer gas can enter the building. Therefore, builders and plumbers take every possible precaution to construct and connect traps so that there is little chance of losing the water seal.

**P trap**

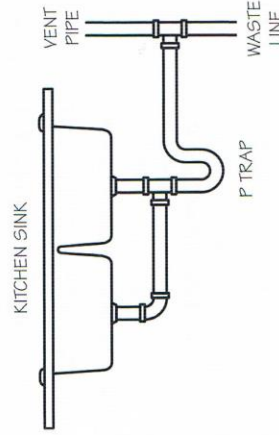
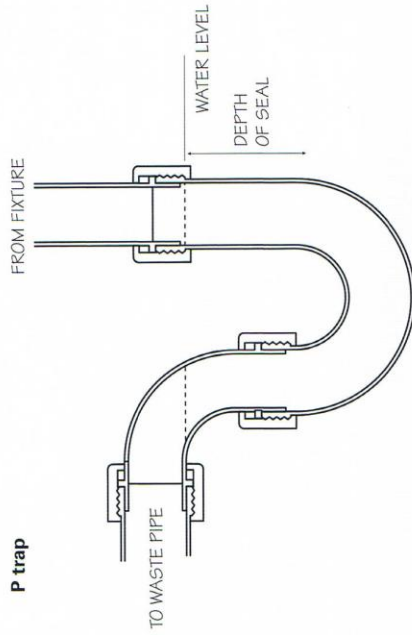

The water seal might evaporate from traps that are not used very often. If you smell sewer gas, make sure all the traps have water in them.

**Know Your Plumbing System**

It is important to know the exact location of the main house drain and the main cleanout. It is important also to find out exactly where the drain runs. In addition, you should know the location of the water main, the water meter, and all valves or shutoffs. Each valve should have a tag attached to it, clearly stating what fixture that particular pipe supplies.

When possible, you should study installations under construction or repair (with permission). Practice sketching the arrangement of pipes, particularly the traps, vents, and connections. The drawings in this pamphlet also will help you. Perhaps a plumber will allow you to look at blueprints showing the system being installed and will explain it to you.

## Freezing

The greatest danger to a plumbing system is freezing. Water expands when it freezes, and it can cause house pipes to burst. Repairing and replacing plumbing and water-damaged property can cost thousands of dollars.

In climates where it freezes in the winter, every outdoor tap that does not have a freeze-proof hydrant should be drained in the fall. Most of these taps have a waste valve inside the house or basement that can be shut off and then drained by loosening a small cap that projects from the valve. The tap should be opened to let air in as the pipe is drained. It should be left open for winter.

In cold climates, pipes often are insulated or wrapped with pipe jacketing or electrical heat tape for added protection. Insulation of certain walls and ceilings also can help protect pipes.

If you know the weather will be very cold on a certain day or night, you can take steps to help keep your pipes from freezing. Open a few faucets to let water slowly drip out. Moving water does not freeze as easily as still water. Also, open cabinet doors to let the warm air of your home reach the pipes under sinks. In very cold areas, use freeze-protection tape and pipe insulation that can be bought at the local hardware or home improvement store.

If you have a power outage, your home and its pipes may drop below freezing temperatures. When the power comes back on, you can turn up the house heat and wait for the pipes to thaw. Frozen water in a pipe will sometimes thaw, and the pipe will be fine. Other times, a crack will have developed.

You will know a pipe has frozen if your water does not flow. If the hot water runs, but not the cold, you will know it is the cold-water pipe that has the frozen place. By the same token, if the hot water will not flow, you will know that the hot-water pipe has frozen.

Never use any kind of open flame to thaw a pipe—a house fire could result. The high heat can travel down the pipe and ignite materials such as the wood and plaster inside the wall. The materials may smolder for a while and then burst into flame many hours later.

## How to Safely Thaw a Pipe

If you need to thaw a pipe by hand, do it the safe way. First, turn off the water to the frozen pipe by using the appropriate shutoff valves. Second, open the faucet that the frozen pipe supplies so that the steam that will form when you heat the pipe can escape. Steam pressure can burst a pipe.

You can use a hair dryer to thaw the pipe. When using a hair dryer, do not get the pipe so hot that you cannot touch it. Keep the hair dryer moving. A cookie sheet between the wall and the pipe will help protect the flammable materials of the wall.

Another way to thaw a pipe is to wrap and tape a towel to the affected part, and then pour hot water onto the towel. Be prepared to deal with the hot water that will drip off the towel, however.

After you have thawed a pipe, check it visually for cracks and leaks.

## How to Winterize Plumbing

In summer cottages or in homes where the family will be away for a long winter trip during which the heat will be off, all pipes and the water heater must be thoroughly drained. Also, all traps must be treated to prevent freezing and damage. To winterize a house, follow these steps.

**Step 1**—An adult should turn off the power (electric or gas) to the water heater and then drain it.

**Step 2**—Shut off the main water valve, then open the drain valve at the lowest point in the water system.

**Step 3**—Open all faucets to allow air to enter the pipes from above. In addition, all drain valves should be drained so that no water remains in them.

**Step 4**—Detach the flexible hoses on dishwashers and washing machines.

**Step 5**—If the house has a pumping system, carefully drain the pressure tank and the pump itself. Turn the pump a few times to make sure the water is out of all its parts. If water piping is installed in such a way that the water will not drain out, then air must be blown into the pipes from an air compressor to push the water from areas where it might collect.

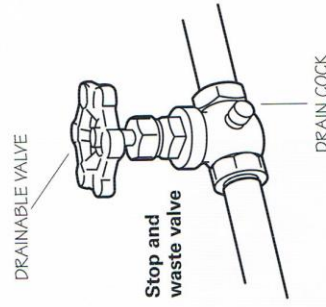

In addition to the above steps, treat all the traps in the house so that they will not freeze. It would be risky to empty the traps completely (this would let sewer gas into the house). The best thing to do is put a solution of antifreeze made especially for RVs (recreational vehicles) mixed with water into each of the smaller traps and into the toilet bowl and with full-strength RV antifreeze in the main house trap. Be sure to follow the instructions on the antifreeze container, and to use *RV antifreeze only with your parent's permission and under the direct supervision of a responsible adult*. The toilet tank should be flushed empty before the antifreeze is added to the water in the bowl. Never pour antifreeze into appliances such as dishwashers or in any water-supply pipes. Use the RV antifreeze only in the drainpipes and their traps.

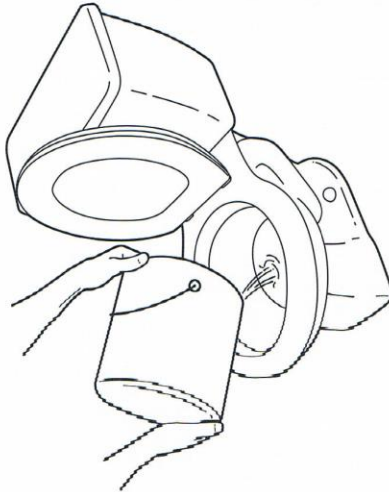

**Pouring RV antifreeze and water solution in the toilet bowl**

When using RV antifreeze to winterize the plumbing in your house, be sure to do so only with your parent's permission and under the direct supervision of a knowledgeable and responsible adult. Follow the manufacturer's instructions on the RV antifreeze container.

## Health and Safety Issues

Plumbing systems carry water into and out of a home through a system of pipes. For the health and safety of the people who live there, the water entering the home through the water-supply system must be pure and clean.

Wastewater and sewage being carried away from the home by way of the drainage system may contain bacteria, viruses, and fungi that can cause serious diseases and set off allergies. Wastewater should *never* come into contact with the water that the family uses for drinking, bathing, or washing clothes and dishes. This is the main reason that it is essential that your family's plumbing system be properly installed and regularly checked to make sure it is in good working order.

### National and Local Plumbing Regulations

Plumbing regulations have been developed to help make sure that plumbing is installed and maintained correctly. These regulations, commonly called plumbing codes, are important in preventing the water-supply system from becoming contaminated and for preventing the spread of disease. National plumbing codes exist that give specific regulations for all plumbing operations. Many communities have adopted these regulations or amended them to fit their local needs. These regulations are for everyone's protection.

Plumbing regulations vary according to location. For example, regulations for areas with hard water, which causes mineral deposits to build up on copper pipes, may not allow copper pipes. Regulations for areas that get lots of snow and ice may call for taller vent pipes on the roof.

The offices of your local health department, building commission, and planning and zoning department will have a copy of local plumbing regulations. Their phone numbers are listed in the government (blue) section of your phone book. You also can find a copy of local regulations or of national regulations at your library. Ask a reference librarian for help.

## Repair Precautions

Do-it-yourself repairs are simple and low-cost, unless you forget the basic rules of plumbing repair: **Turn off the water supply before you start, and call a professional for anything other than the most basic plumbing problems.**

Here are some guidelines that will help you make repairs safely.

- Protect the area where you are working before you start, because you probably will spill some water.
- Protect chrome finishes with a cloth pad while you work.
- Wear protective gloves and goggles to avoid injury to the skin and eyes when using chemical drain cleaners to unclog a drain.
- Keep power tools away from areas where water has leaked to avoid shock hazards.
- Try to contain spilled water with towels or a wet-dry vacuum cleaner.



## Health and Safety Tips



- Properly maintain your hot-water heater. A hot-water heater that is not functioning properly can cause serious injury or even death. Modern water heaters are controlled by a thermostat and must have properly working pressure- and temperature-relief valves that prevent over-heating, fires, and explosions. It is dangerous to plug a hot-water heater's relief valve. If the valve leaks or needs to be replaced, call a plumber.

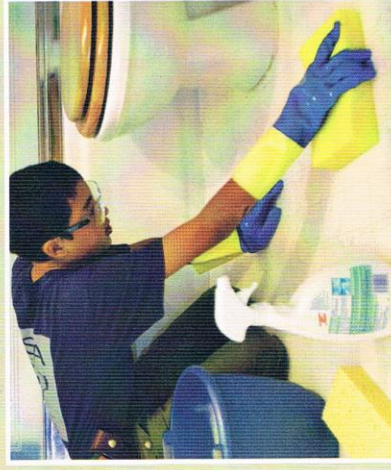

- If a clogged toilet contains raw sewage, or if the sewage has overflowed onto the floor, wear protective gloves and goggles during cleanup to avoid contaminating yourself or others. Make sure to sanitize the area afterward with bleach or disinfectant.
- Keep flammable materials away from the hot-water heater. Never store flammable materials in the same area.
- Repair all leaks immediately. Otherwise mold or other growths may contaminate the entire household.

## Plumber's Tools and Their Uses

Many of the tools used in plumbing will be found in your family tool chest. As a Scout, you will, of course, handle tools carefully, especially borrowed ones. Keep them clean and free from rust. Have a place for each tool and keep it there. Your care will pay off in better workmanship and the satisfaction that goes with it.

Your merit badge counselor may be able to get permission for you to use plumber's tools in a trade school classroom or in a plumbing contractor's pipe shop. A neighborhood plumber may be willing to let you use a workbench, vise, and tools and advise you on their use.

Community colleges and technical schools offer excellent plumbing courses.

### Commonly Used Tools

Below are descriptions of the most commonly used plumber's tools and explanations about how to use them properly.

#### Wrenches

- The *pipe wrench* is cleverly designed to grip and turn a pipe. Its teeth bite into the pipe and hold it firmly. The wrench can turn the pipe in only one direction at a time. To turn a pipe in the opposite direction, you must remove the wrench and turn it around.
- A *chain wrench* is good for fairly heavy work. It can grip pipes in hard-to-reach places, and it has considerable leverage.
- An *adjustable wrench* works well to tighten and loosen the nuts on faucets and other fixtures.
- A *basin wrench* can be used to tighten hard-to-reach nuts behind sinks.
- A *strap wrench* is good for chrome and for plastic pipes because it will not mar their surfaces.

Pipe wrenches come in a number of sizes.



### Augers

- A *plumber's auger*, or "snake," is a flexible ribbon or coil of spring steel that can be used to clean out plugged drains.
- A hand-crank *drain auger* is good for clearing out clogged sinks and traps.
- A *closet auger* is made to clear toilets.
- A *commercial auger* is a power-driven device for cleaning out a badly clogged waste stack. The device has a rotating blade that can travel along inside the pipe, chewing its way through the material causing the trouble, including tree roots that have grown into the joints of the house sewer.

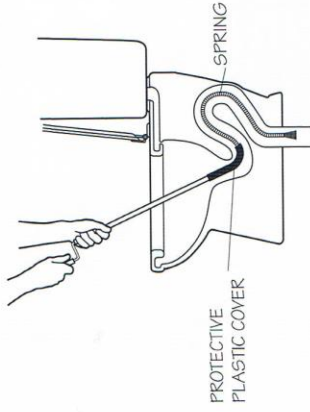

Using a closet auger to unclog a toilet

### Other Tools of the Trade

- *Needle-nose pliers* can be used to remove O-rings and clips of faucets.
- *Tongue-and-groove pliers* can be adjusted to grip many different sizes of pipe.
- A *plunger* (sometimes called a "rubber force cup") is a large rubber suction cup attached to a wooden handle. This tool can clear drain stoppages, particularly those in toilet drains.
- A *level* helps plumbers make sure that the components of the drainage system are properly sloped downhill.
- A *pipe cutter* cuts gradually as it is turned around the pipe. When using a pipe cutter instead of a hacksaw, you will more easily make a straight—not slanted—cut. A pipe cutter also makes it easier to avoid bending or crushing a copper pipe.





Plungers

A plunger should never be used to postpone a needed cleanout, and it does not work well to open vented pipes; it merely pushes the water up the vent. It may even force the stoppage into the vent, plugging it.

- A pipe vise, bolted to the workbench or tripod, is used to hold steel pipe for cutting, reaming, and threading.
- Dies for threading pipe come in standard sizes. They are held and adjusted in the *diestocks*, the long handles of which give plenty of leverage for cutting threads. A *guide*, or *follower*, is used when cutting threads to guide the stocks straight onto the pipe. The die, diestock, and guide can be combined in one handy tool.

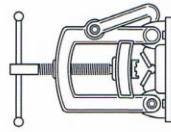

Pipe vise

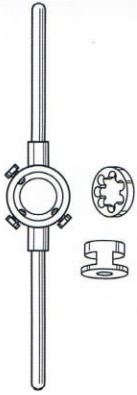

Combination tool with die, diestock, and guide

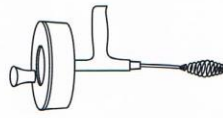

Plumber's auger, or "snake"



Closet auger

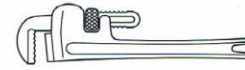

Pipe wrench



Tongue-and-groove pliers



Reamer

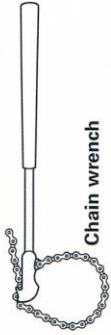

Chain wrench

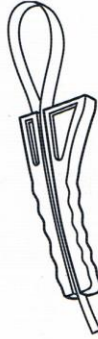

Strap wrench



Basin wrench



Level



Plunger, or force cup

### Soldering Tools and Materials

Plumbers use a metal filler called *solder*, which can be melted to join two pieces of metal. Solder is an alloy, or blend, of tin and other metals that melts at a lower temperature than the pieces of metal being joined. Different proportions of metals are used to give the solder the qualities needed for the kinds of jobs to be done.

Pipe must be absolutely clean (use sand cloth or emory paper) to hold a tight solder connection. *Flux* is a substance used to remove any oily film or dust that might keep the solder from uniting with the metal. Flux also removes oxides (thin layers of rust or tarnish) and prevents further oxidation while the metal is heated to the soldering temperature.

**Use only lead-free solder.** Although lead-tin solder is still available, it contains lead and releases poisonous fumes. Over time, inhaling these fumes can cause brain damage, and the lead from the joint could leach into the home's water supply.

A portable gas torch is a plumber's main tool for soldering. It heats pipe quickly to temperatures high enough for solder to unite with pipe metal. You must use a fireproof guard shield when you are working near flammable material, such as a wall or house framing. You will need a spark lighter to light the gas unless you have a self-igniting torch.

**Be careful not to get any flux or hot solder on your skin—it will burn you. A noncorrosive flux should be used on plumbing.**



**When using a gas torch, do so only under the close supervision of a responsible adult. Closely follow the manufacturer's instructions.**

## Pipes and Fittings

Pipes and fittings are made of many different materials. Homes built before the 1950s were built with cast-iron and galvanized-steel pipes. Newer homes use copper and plastic pipes.

### Kinds of Pipes

Some types of pipe are no longer used. For instance, a kind of plastic pipe called PVC used to be installed for hot- and cold-water supply, but the hot water made the pipe lose its strength and the joints leak. For this reason, PVC pipe is no longer recommended for use in the indoor water system. Another outdated product is the galvanized steel pipe. Galvanized-steel pipes are strong at first, but corrode and leak after about 50 years. These days, steel pipes are used mostly for gas installation, not for water.

You can join pipes made of different materials if you follow your local code and use the proper fittings.

### Kinds of Fittings

Plumbing and gas pipes are joined together with fittings. Fittings come in a variety of shapes, sizes, and materials to suit different plumbing needs.

- *Elbows* are used to change the direction a supply pipe is going. An "el," as it is also called, usually will have a 45- or 90-degree angle.
- *Bends* are the DWV system's version of elbows. Their angles are gradual so that solid waste can move through them without getting stuck.
- Fittings called tees look like the letter T. They are used to join two pipes that intersect at a right angle. If the pipes that intersect are not the same diameter, you can use a *reducing tee*.

- The DWV system uses tees, as well as Y's and crosses. These DWV fittings are referred to as sanitary branches and are used where two or more drains intersect.
- *Couplings* connect pipes in a straight line, or *run*. *Reducing couplings* are used between pipes of different diameters.
- *Unions* are needed because all pipes have right-hand threads, and at some point you will need to disconnect the line without having to cut it.
- *Nipples* are short pieces of pipe with threads on both ends. They are used to join fittings.
- *Transition fittings* are used to join different kinds of pipe, such as plastic to copper. (Transitions should not be used to join two kinds of plastics.)
- *Dielectric fittings* are used when joining steel to copper. The special plastic spacer in a dielectric fitting keeps the metals apart. (Steel and copper corrode if they touch.) However, the plastic piece also causes an interruption in the "grounding" of a pipe. If a live electrical wire touches the metal pipe, the pipe will be dangerous to touch.
- *Caps* are used at the end of a pipe to close it. *Plugs* are types of caps used on a threaded fitting such as a cleanout hole.

Fastening steel to copper without a dielectric fitting is like dipping something in acid—the metals get eaten up. This is why a plastic fitting is used to "connect" these two types of pipes.

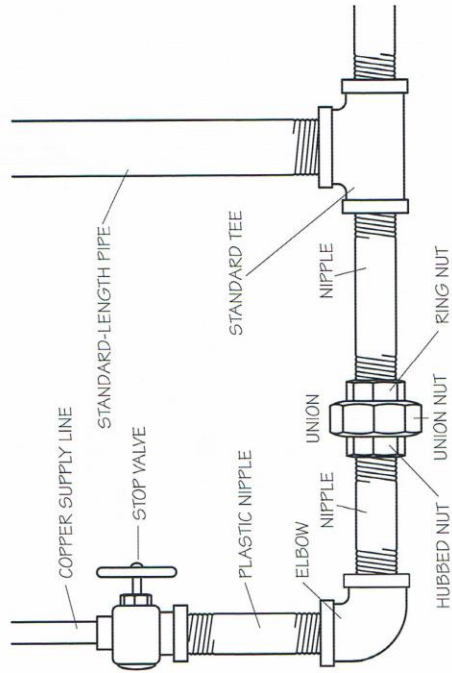

Example of pipes and fittings joined together

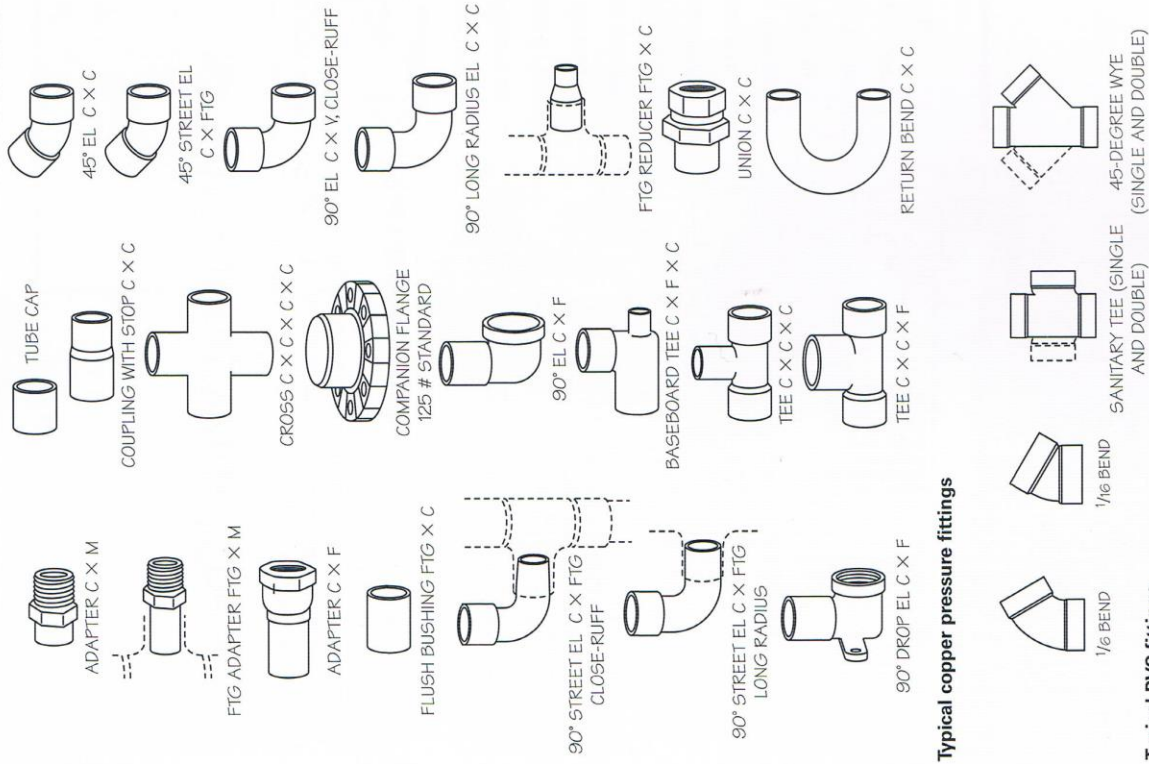

Typical copper pressure fittings

Typical PVC fittings



# Working With Pipe

Before you try out the projects for requirements 6 and 7, examine the various kinds of pipe and understand how to cut them to proper lengths, thread them, and fit them together.

## Pipe Measurements

The only constant in pipe measurement is that there is no universal standard for dimensions in the different types of pipe and fittings. Work closely with your merit badge counselor to correctly measure the pipe you will use.

### Length

Straight pipe length measurements are always given from end to end. When a fitting is used on one end of the pipe, the measurement reads from the end of the pipe to the center of the fitting. If a fitting is used on each end, the measurement reads from the center of one fitting to the center of the opposite fitting.



### Diameter

Most pipes are known by their inside diameter (ID). If you can access the inside of a pipe, you can measure this yourself. You may have to round your number to the nearest 1/8" to get the nominal size, which is the size used to name it at the hardware or plumbing store. For instance, supply pipes usually are 1/2",

3/4", or 1" nominal size, although the exact inside diameter may be slightly more or less. If you cannot measure the inside of the pipe, you can wrap a measuring tape around the outside to determine its outside circumference. Write down that measurement and note the pipe material. The chart shown on the next page will help you determine how outside diameter measurements correspond to inside diameter measurements.

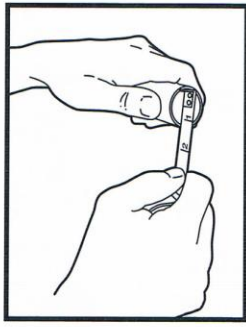

Measuring the inside diameter of a pipe

Pipe fittings usually have the size stamped on the outside. When you order a reducing pipe fitting, which joins two different sizes of pipe together, name the larger part of the fitting first.

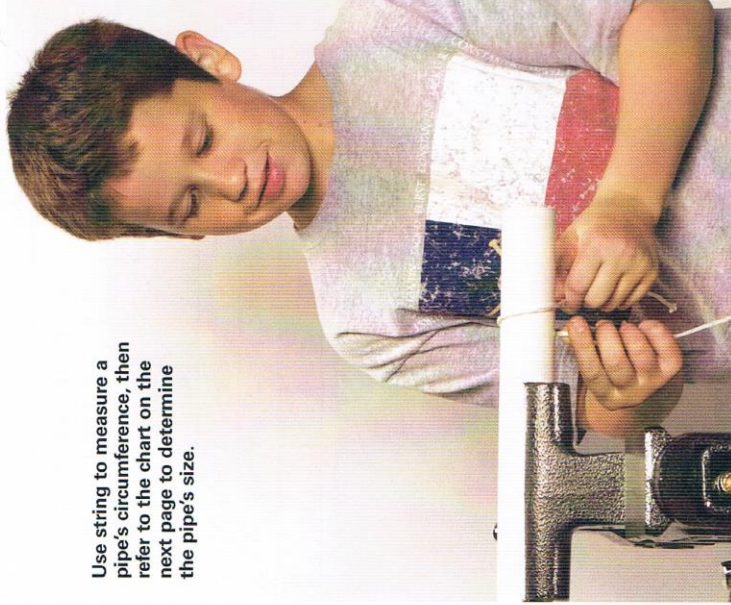

Use string to measure a pipe's circumference, then refer to the chart on the next page to determine the pipe's size.

## Pipe Measurements and Dimensions

Material	Inside Diameter (ID)	Approximate Outside Diameter (OD)	Approximate Circumference	Approximate Socket Depth
Copper	1/4"	3/8"	1 1/8"	5/16"
	3/8"	1/2"	1 1/2"	3/8"
	1/2"	5/8"	2"	1/2"
	3/4"	7/8"	2 3/4"	3/4"
	1"	1 1/8"	3 1/2"	15/16"
	1 1/4"	1 3/8"	4 5/8"	1"
	1 1/2"	1 5/8"	5 1/4"	1 1/8"
	2"	2 1/4"	7"	3/4"
Threaded	3/8"	5/8"	2"	3/8"
	1/2"	3/4"	2 3/8"	1/2"
	3/4"	1"	3 1/8"	9/16"
	1"	1 1/4"	4"	11/16"
	1 1/4"	1 7/8"	4 3/4"	11/16"
	1 1/2"	1 3/4"	5 1/2"	11/16"
	2"	2 1/4"	7"	3/4"
	1/2"	7/8"	2 3/4"	1/2"
	3/4"	1 1/8"	3 1/2"	5/8"
	1"	1 3/8"	4 1/8"	3/4"
	1 1/4"	1 5/8"	5 1/4"	11/16"
	1 1/2"	1 7/8"	6"	11/16"
2"	2 3/8"	7 1/2"	3/4"	
3"	3 3/8"	10 1/2"	1 1/2"	
4"	4 3/4"	14"	1 3/4"	

## Threading Steel Pipes

To complete requirement 6, you will need to cut, thread, and connect two steel pipes. Your pipe should be about 2 feet long, although you can use a piece a foot or more long. Dies and diestocks can be rented.

Because you will always have to measure any pipe you are going to cut, you should use a tape measure or ruler and mark the exact middle of your pipe with a dark pencil or crayon. Now, put the pipe in the vise, with the cutting mark extending far enough from the vise so that the cutter or threader will not be cramped or strike the bench while turning. Complete requirement 6 by following the illustrations and descriptions in this section.

**Step 1—Cutting steel pipe.** Tighten the cutter on the pipe as shown, with the small cutting wheel directly on your pencil or crayon mark. Now push the cutter around the pipe, gradually tightening the handle clockwise. As you finish the cut, turn slowly in order to leave a smooth edge.

**Step 2—Reaming.** Use the reamer and remove the burrs left in the end of the pipe. Burrs are sharp, so be careful not to cut your hands.

**Step 3—Threading.** Apply the threader to the end of the pipe with enough pressure for the chasers (cutting edges) to take hold. Turn gently until you are sure you have a good clean start. (If you do not get the die squarely on the pipe, the threads will not work in a fitting.) Oil frequently with cutting oil to reduce friction, checking the chart shown here for the number of threads required.

- Materials**
- Pipe vise
  - Threading stock (unthreaded steel pipe)
  - Dies to fit your pipe (3/4" or 1" pipe would be best)
  - Steel coupling of the proper size
  - Pipe wrench
  - Pipe cutter
  - Reamer powered by a brace or drill
  - Small can of cutting oil
  - Pipe compound (pipe dope) or Teflon pipe tape

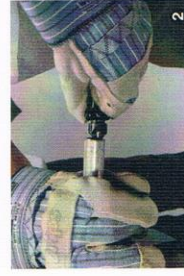



**Step 4—Checking the set of threads.** This is how your threads should look when finished.



**Step 5—Applying pipe compound or pipe tape.**

Put pipe compound on the threads you have cut if your pipe is for gas lines. Wrap pipe tape clockwise on the threads if your pipe is for water lines. Compound or tape will ensure a joint that is leakproof.



**Step 6—Installing a coupling.** Install your coupling, tightening it firmly with the pipe wrench. Now repeat the steps with the second piece of pipe and tighten it into the other side of the coupling.

Plumbers have a formula they follow in threading pipe of different sizes to ensure maximum strength of joints. They also follow a formula in screwing steel pipe into fittings. By using the same standards, they know how to cut and thread pipe quickly when making repairs, without having to measure each set of threads. Below is a chart showing the principal fittings for steel pipe.

## Soldering Copper Pipe

Nearly all houses built today contain copper plumbing. Copper does not rust, and it will last the lifetime of the building in which it is used. Rigid copper pipe and flexible copper tubing are simple to install and can be fitted into corners where wrenches cannot be used.

Rigid copper pipe with soldered fittings makes a more permanent installation. This pipe comes in 10' and 20' sections and is easily cut to the length required. Many sizes of rigid copper pipe are available, but the most common for household use are 1/2", 3/4", and 1" diameter. Since rigid copper pipe is relatively soft, it is easy to cut with an inexpensive tube cutter.



### Safety Rules

When working with metal, flux, and high temperatures (gas torches), you should be aware of possible dangers. The following rules will help keep your plumbing activities safe and enjoyable.

- Always work with adult supervision.
- Always wear safety goggles or safety glasses, a shop apron, and, when necessary, protective gloves.
- Protect your skin from flux. It is an acid, so it will burn your skin.
- Avoid touching metal where it has just been cut. The burrs are sharp. Sweep up burrs with a brush, not your hands.
- Treat every cut immediately, no matter how minor.
- The pipe and fittings are hot and should be handled carefully.
- Avoid soldering near flammable materials.
- Keep a fire extinguisher handy.

### How Far to Screw Pipes Into Fittings

Pipe Size	Screw Pipes Into Fittings
1/4"	3/8"
1/2"	7/8"
3/4"	1"
1"	1 1/8"
1 1/2"	1 5/8"
2"	2 1/4"

### Threads Per Inch

Pipe Size	No. of Threads Per Inch	Length of Thread on Pipe
1/4"	18	3/8"
1/2"	18	7/8"
3/4"	14	1"
1"	14	1 1/8"
1 1/2"	11 1/2	1 5/8"
2"	11 1/2	2 1/4"

## How to Cut and Solder

Requirement 7 asks you to solder three copper tube connections.

The following steps will help you complete this requirement:

### Materials

- Propane or acetylene propane gas torch
- Lead-free solder (wire type)
- Noncorrosive flux
- Steel wool or sand cloth (emery paper)
- Vise or clamp
- Pipe cutter suitable for copper
- 3 feet of 1/2" or 3/4" rigid copper pipe
- Tee of proper size
- Coupling

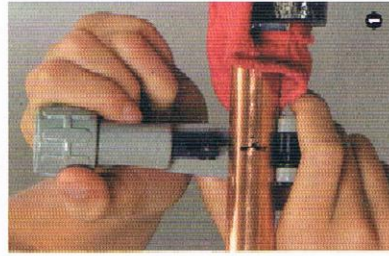

**Step 1**—Measure the pipe to divide it into two equal sections. Mark it with a dark pencil. Place the pipe in your vise, cushioning it to prevent vise marks or bending the pipe. Allow enough pipe to stick out so that your pipe cutter can turn freely. Place the cutting disk exactly on your mark and start turning the cutter shaft. Twist the handle clockwise as you turn. Complete the cut slowly so that you leave as little burr as possible. Burrs can cause leaks.



**Step 2**—Use the reamer as you did with your steel pipe to remove the burrs from the cut ends of the inside of the copper pipe.

**Step 3**—Use steel wool, sand cloth, or fine sandpaper to burnish the outside and end of the pipe and the inside of the coupling. To keep the burnished areas free from new oils, try not to touch these places with your fingers.



Instead of a pipe cutter, you can use a hacksaw with a fine-toothed blade to cut the tubing. A miter box will help you make a straight cut. Slanted cuts are not acceptable when joining pipes.

**Step 4**—Apply noncorrosive flux to the outside of the pipe and to the inside of the end of the coupling you are going to use. Twist the pipe into the coupling to make sure the flux is evenly distributed.



Use enough flux to just barely cover the necessary surface. Do not use more flux than is needed. Brush off any excess. Do not touch the flux, because it will chemically burn you.

**Step 5**—Light the torch, turning it up to a soft flame. Evenly heat the pipe joint. As soon as the flux is bubbling well and the pipe is hot enough to melt solder, turn off the torch. Gently push the solder into the joint as shown. It should flow freely around and into the joint. When smooth silver shows all around the fitting, you can cool the joint with a damp (not wet) cloth or sponge. Be careful not to burn yourself. The water on the cloth will soon carry the heat to your hand.

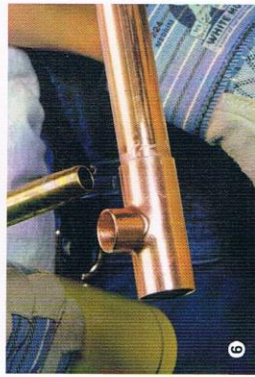

**Step 6**—Remove the burr from your second piece of tubing, burnish and flux the tubing and coupling, and solder the other side of the coupling exactly as you did the first piece.

**Step 7**—Remove the burr from both open tubing ends and solder the tee to one of them. Follow the same process as you did before to complete the project.

Pull out about 10 inches of solder wire and bend it at an angle. This preparation will help you maneuver the solder without burning your fingers.

## Home Plumbing Repairs

Shutting off the water is always the first thing you must do before making a home plumbing repair. Some home plumbing repairs can be made without shutting off the main supply valve, as long as an individual shutoff valve for the pipe that feeds the repair area has been shut off. For instance, if you are planning to replace a faucet seat washer, you may find the shutoff valve underneath the sink or lavatory (bathroom sink). If no such valve has been installed, or if you find the individual valve is not working correctly, you **must** shut off the main valve in the basement or crawl space or near your water meter outside.

### Faucets

There are two main types of faucets: compression and noncompression.

If your faucet has two handles, one for hot and one for cold, it is most likely a compression faucet.

Compression faucets also are known as stem faucets because when you turn the handle to the “off” position, the stem moves down. A rubber washer at the bottom of the stem presses into the valve seat and blocks the flow of water. If the washer is worn or crumbling, it will not seal out water. That little bit of water getting past the washer causes a drip, drip, drip. It’s a waste of a vital natural resource, and it becomes expensive over time.

### Replacing a Washer in a Compression Faucet

A leaky faucet is annoying, and it wastes water. You can fix many faucet drips yourself if you know how to change a washer.

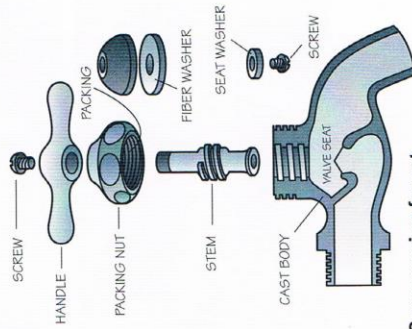

Compression faucet

**Step 1**—Turn off the water. Usually, you will find a pair of shutoff valves under the sink. Check to make sure the shutoff valves work. Sometimes they need repairing and do not stop the water completely. If the water still runs from the faucet after you have shut it off under the sink, have an experienced adult help you turn off the water supply at your home’s main water-supply valve.

**Step 2**—Turn the handles to the faucets “on” to drain the remaining water from the pipes. Next, close the stopper in the sink so that no small parts will be lost down the drain. Lay a towel in the sink to prevent nicks and scratches.

**Step 3**—Begin taking the faucet apart by finding the screw that holds the handle. Sometimes the screw is hidden by the escutcheon, or decorative cap, which indicates “H” for hot or “C” for cold. Pry off the cap with the tip of a flathead (slot) screwdriver. Protect chrome surfaces by padding them with a cloth while you work.

**Step 4**—After removing the screw, take off the handle. If the handle is hard to remove, gently tap or pry it on one side, then another. Do not pry too hard, or you might crack the handle or faucet body. (If the handle is really stuck, a tool called a “handle puller” can be used to grasp the handle and pull it off the stem.)

**Step 5**—Remove the retaining nut (also called a lock nut or packing nut) with an adjustable wrench. Turn counterclockwise to loosen.

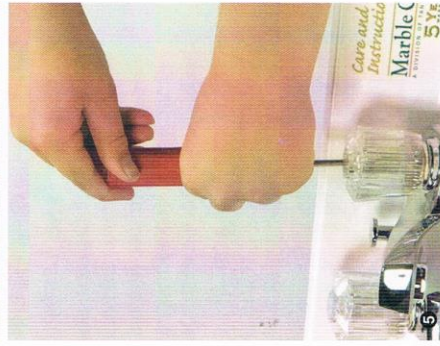
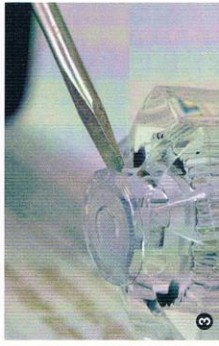

As you take apart the faucet, carefully lay each piece on a nearby towel in the order that you remove it. This important practice will help you know how to put the faucet back together after you have replaced the old parts.

Remember, turning right tightens (“righty, tighty”). Turning left loosens (“lefty, loosey”). Right turns are clockwise, and left are counterclockwise.



**Step 6**—Pull up on the stem assembly to remove it. You can use your hands, or a pair of pliers wrapped with cloth. Turn the stem counterclockwise a bit if you need to loosen it.

**Step 7**—Use a screwdriver to take off the brass screw that holds the washer in place. If the screw is stuck, use a bit of super lubricant such as Liquid Wrench to help loosen it.

**Step 8**—Clean any dirt or corrosion off permanent parts with an old toothbrush or fine steel wool before putting the faucet back together. Dip the brush or steel wool in vinegar to help dissolve mineral deposits on parts.

**Step 9**—Choose a washer that is the exact shape, size, and thickness as the old washer. All-purpose repair kits for compression faucets contain a variety of washers, but if you cannot find a match, take the old washer to the hardware store. The brand name of your faucet also will help you identify the correct washer.

**Step 10**—If your kit has a new screw that matches the old one, use it to attach the new washer to the stem. Put the flat side of the washer against the base. Put the faucet back together in the reverse order of how you took it apart. Turn on the water, and see if you have fixed the leak.

If the spout is dripping, replacing the washer or fixing the valve seat probably will stop the leak. However, if the handles are dripping, the O-ring and/or packing is probably to blame. You can try tightening the retaining nut first. Pry off the O-ring and replace it, using silicone gel on the new one. Wrap new packing around the stem. Packing string is made of rubber or of asbestos and wax, and it creates a waterproof seal.

### Repairing Noncompression Faucets

Many noncompression faucets have one handle to adjust the hot and cold water. Some have two handles and look like compression faucets until you take them apart.

If you have to replace washers every few months, the seat valve may be “chewing up” your washers. You may need to replace or resurface the seat valve. Check out a book from the recommended list in the resources section for instructions.

Noncompression faucets do not have washers. Instead, they have a ball mechanism, a disk mechanism, or a cartridge. Noncompression faucets can also be fairly simple to repair. The key to repairing and replacing parts for these faucets is to:

- Know the make and model number of your faucet or take the parts with you to the hardware store so you can find the correct replacements.

- Remember when taking apart the faucets to keep track of the order of the parts. You can write down or sketch the assembly.

For detailed instructions on your type of noncompression faucet, check out a plumbing book from the list of recommended books in the resources section of this pamphlet.

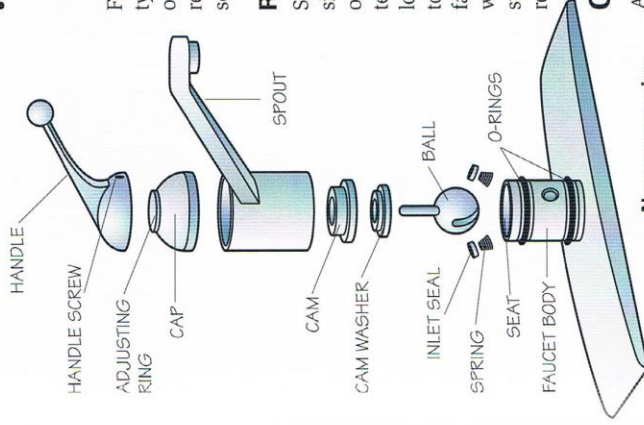

Noncompression, single-lever faucet

### Repairing Shower Faucets

Shower faucets are similar to those on a sink or lavatory. Because of the positioning of the faucet body in the wall behind plaster and tile, their stems are usually quite long. You may need to use a socket wrench to remove the stem nut. Treat shower faucets like any other compression faucet when the shower head drips water. Make sure the seats are in good condition and replace washers and packing as needed.

### Cleaning Pipes and Traps

All waste pipes can get clogged. Dirt may collect in the bottom, and grease can stick to the sides. When water or waste will not

run out of a sink, tub, or toilet, the problem is that debris is blocking the route in the pipe or trap. Try the following remedies. If the first one does not work, move on to the next one listed until you clear the blockage.

- 1. Remove the stopper or drain cover.** Clean off any accumulation of soap scum and hair with paper towels and pipe cleaners.
- 2. Try a commercial drain cleaner.** Commercial drain cleaners can help clear a clog that is causing a sink or tub to drain slowly. Give the cleaner plenty of time to work—a few minutes longer than specified on the package. If the drain is still slow, do not risk a chemical burn by immediately trying repairs involving augers, cleanout plugs, or trap removal. Continue to use the sink or tub to completely flush out the chemical. Be sure to follow the manufacturer's instructions. Try further repairs in a day or so.

**Never use caustic commercial chemical drain cleaners in a completely clogged drain or in a toilet. Flush any chemicals thoroughly from the trap to be worked on. If the chemicals cannot be flushed out, it is time for a responsible adult or plumber to take over.**

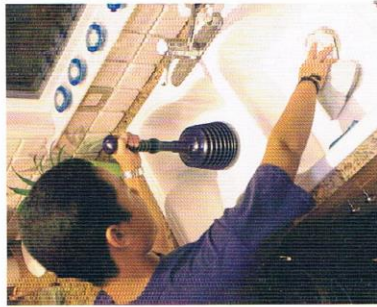

- 3. Loosen a clog with suction.** Petroleum jelly applied to the base of a plunger helps seal it to the sink. Block the overflow holes or any other sink drains with wet rags (someone should hold it in place). Fill a sink with enough water to cover the plunger and create more of a seal. If you are plunging a toilet, leave enough water in the toilet to create a seal but not so much that it overflows when you plunge. Use steady, rhythmic, and forceful downward strokes to clear the clog. Plunge 10 times, and then test the flow. Repeat the procedure three to five times, if necessary. Once the water drains freely in a sink, flush the drain with hot water for five minutes.

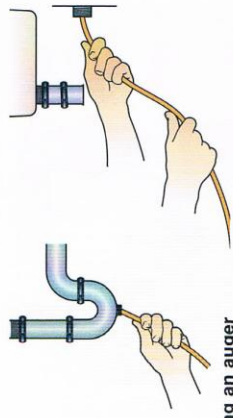

- 4. Insert a "snake," or auger, into the drain or pipe to dislodge a persistent clog.** Before you begin, use towels to protect the surface from chips or scratches. Do not be too forceful with the auger.

#### Inserting an auger

If you do not have an auger, you can find an inexpensive one at a home supply store, or you can rent one.

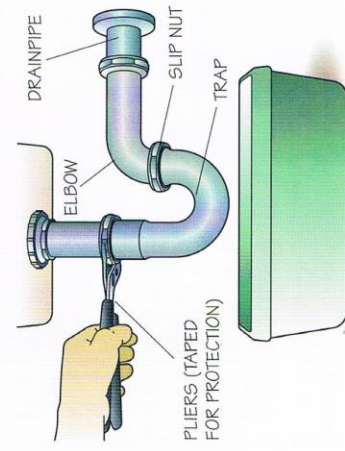

#### Opening the trap

- 5. Clean the trap.** If all else fails, place a container under the trap to catch the water. Open the cleanout plug. If the trap does not have a cleanout plug, remove the trap. Keep the pail under the trap, and loosen the slip nuts. Pad the teeth of an adjustable wrench with tape or cloth so that you do not mar the metal finish. You can use a wrench to loosen the slip nuts for the first turn, and then do the rest of the turning by hand. Support the trap with one hand so that it will not fall unexpectedly.

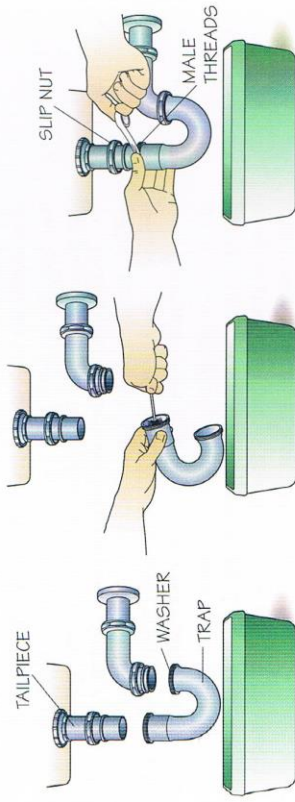

#### Disassembling the trap

#### Cleaning the trap

#### Reassembling the trap

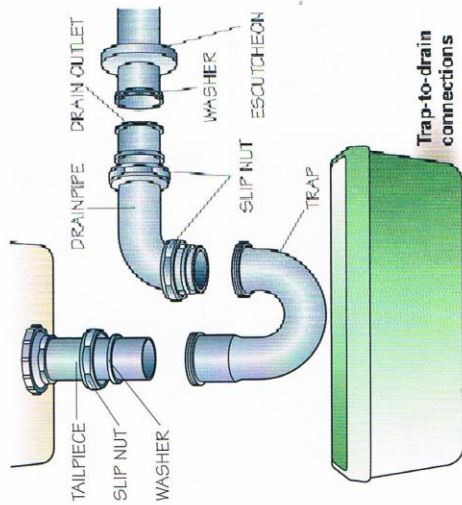

Clean the removed trap by using a small brush or by running a cloth through it. Use an auger to clear the pipes that attach to either side of the trap. When replacing the trap, wrap the "male threads" of the trap with Teflon pipe tape, or brush them with joint compound. Put the trap and the washers into position, and turn the slip nuts by hand. Because slip nuts crush easily, hand-tighten them first. Then use a wrench to give them an additional quarter turn.

Check your work by plugging the basin of your sink and filling it with water. Then remove the plug and inspect the trap and drain fittings for leaks. You may need to tighten the slip nuts a bit more.

## Repairing Toilets

There are two types of toilets: gravity-assist flush toilets and pressure-assist toilets. All gravity-assist flush toilets operate basically the same way. When you flush the toilet, the handle lifts an arm or chain that raises the flush valve, which can be either a ball (in older toilets) or a flapper. Tank water flows out of this opening to flush the toilet bowl. The float ball rides the water level down the tank and turns on the water-intake valve in the ballcock. At the same time, the flush valve drops back into the opening, sealing it to fill the tank again with fresh water.

Pressure-assist toilets are becoming more popular, especially with federally mandated standards for how much water a toilet can use in one flush. Pressure-assist toilets "push" the contents out of the toilet bowl rather than using the pulling action of gravity as in the gravity-assist toilet. Inside the china toilet tank, you will not find any standing water, as in a gravity-assist toilet, so one advantage is that the tank of a pressure-assist toilet never "sweats" in heat and humidity.

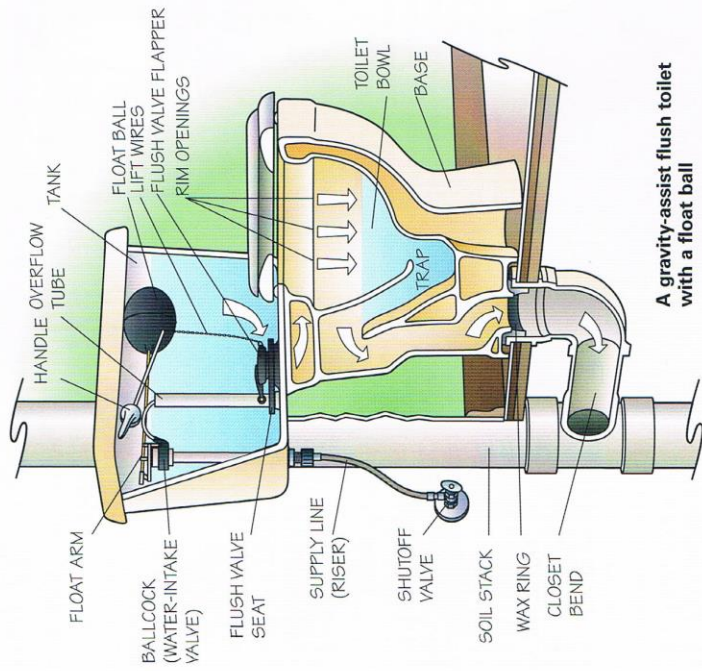

A gravity-assist flush toilet with a float ball

## Clogged Toilet

If the water in a toilet bowl rises to the rim or overflows, something is probably blocking the channel. Follow these steps to try clearing it with a plunger.

**Step 1**—Close the flush valve by hand, putting the flapper or ball stopper back in the closed position. Then turn off the shutoff valve at the side of the toilet.

**Step 2**—Drain excess water from the bowl with an old cup or can. Leave enough water to cover the plunger cup to create a good seal.

**Step 3**—Stand in front of the toilet and plunge vigorously about 10 times.



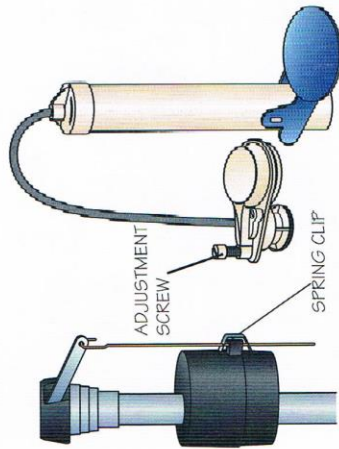

The insides of gravity-assist toilets may vary. With a floating cup ballcock (above left), the position of the floating cup controls the water level. You can adjust the water level by moving the spring clip. To make water-level adjustments with the floatless ballcock (above right), simply turn the adjustment screw.

Sometimes you can see obstructions using a small mirror and flashlight. With the mirror, you can look under the rim to see whether the flush holes are clear. If they are not, try clearing them with the hook end of a straightened clothes hanger. You also can inspect the top of the trap with the mirror and flashlight—but *empty all the water out of the toilet bowl first*. If the clog persists, it is probably time to call a plumber.

### Running Toilet

A running toilet, one that is constantly letting water into the tank, is both irritating and wasteful. It also is one of the easiest and least expensive toilet problems to fix. You might want to drain the tank first by turning off the water supply and flushing. Remember to turn the water supply back on when repairs are done.

Running toilets can have several causes and easy remedies. Remember, turn off the water supply before performing maintenance or repairs.

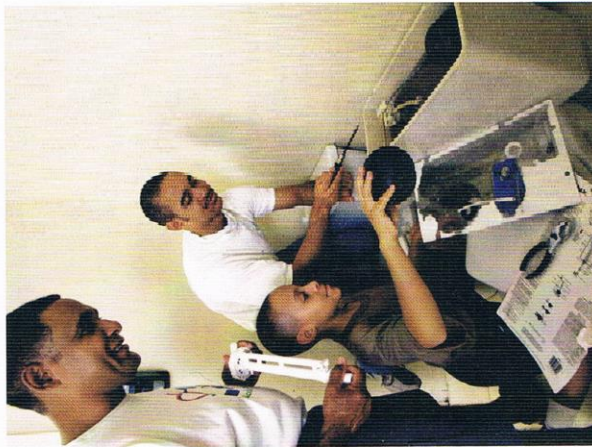

### Problem Solution

#### Leaking float ball

Unscrew the ball to remove it, and install a new one. If a new one is temporarily unavailable, empty the leaky ball, cover it with a plastic bag, and secure the bag with tape or a rubber band.

#### Float arm

If the rod is keeping the water-intake valve open, bend the rod up or down slightly, or adjust its screw.

#### Leaky water intake

Clean corrosion off washers and other valve parts with a toothbrush dipped in vinegar, or install new ones.

#### Faulty flush valve seat

Raise the valve and buff the seat with steel wool. Remove only corrosion, not any metal.

#### Worn flush valve (flapper)

A replacement flapper slides over the overflow pipe or hooks onto lugs. If replacing a flush valve ball, unscrew it from the lift wire. Make sure that the new valve ball falls squarely into the seat of the flush valve.

#### Toilet tank overfills

Examine the flush valve; the repair may be as simple as replacing the flap.

#### Water is going over the overflow tube

Adjust the float arm, adjustment screw, or spring clip. If the water continues to fill past the overflow tube, replace the fill valve.

# Plumbing Resources

## Scouting Literature

*Home Repairs and Public Health*; merit badge pamphlets

Visit the Boy Scouts of America's official retail Web site at <http://www.scoutstuff.org> for a complete listing of all helpful Scouting materials and supplies.

## Books

Better Homes and Gardens editors. *Step-by-Step Plumbing*. Meredith Books, 1997.

Home Depot Books editors. *Plumbing 1-2-3: Install, Upgrade, Repair, and Maintain Your Home's Plumbing System*. Home Depot, 2001.

Popular Mechanics editors. *Home How-To*. Hearst Books, 2000.

## Organizations and Web Sites

**American Society of Plumbing Engineers**

Web site: <http://www.aspe.org>

**International Association of Plumbing and Mechanical Officials**

Web site: <http://www.iapmo.org>

**Mechanical Contractors Association of America**

Web site: <http://www.mcaa.org>

**Plumbing-Heating-Cooling Contractors Association**

Web site: <http://www.phccweb.org>

**United Association of Plumbers and Pipefitters**

Web site: <http://www.ua.org>

## Acknowledgments

The Boy Scouts of America thanks retired Master Plumbers Jim Witten and Sam Huff for their time and expertise in updating this edition of the *Plumbing* merit badge pamphlet. Thanks also to Gerry Kennedy of the Plumbing-Heating-Cooling Contractors' National Association Education Foundation.

## Photo and Illustration Credits

HAAP Media Ltd., courtesy—cover (*running faucet*)

HAAP Media Ltd./Yucef Tellici, courtesy—cover (*basin at lower left*)

Photos.com—cover (*all except merit badge, running faucet/basin, plunger*) and page 22

All other photos and illustrations not mentioned above are the property of or are protected by the Boy Scouts of America.

Daniel Giles—page 46

John McDearmon—all illustrations

## MERIT BADGE LIBRARY

Though intended as an aid to Boy Scouts, Varsity Scouts, and qualified Venturers in meeting merit badge requirements, these pamphlets are of general interest and are made available by many schools and public libraries. The latest revision date of each pamphlet might not correspond with the copyright date shown below, because this list is corrected only once a year, in January. Any number of merit badge pamphlets may be revised throughout the year; others are simply reprinted until a revision becomes necessary.

If a Scout has already started working on a merit badge when a new edition for that pamphlet is introduced, *he may continue to use the same merit badge pamphlet to earn the badge and fulfill the requirements therein*. In other words, the Scout need not start all over again with the new pamphlet and possibly revised requirements.

Merit Badge Pamphlet	Year	Merit Badge Pamphlet	Year	Merit Badge Pamphlet	Year
American Business	2002	Engineering	2008	Photography	2005
American Cultures	2005	Entrepreneurship	2006	Pioneering	2006
American Heritage	2005	Environmental Science	2006	Plant Science	2005
American Labor	2006	Family Life	2005	Plumbing	2008
Animal Science	2006	Farm Mechanics	2008	Pottery	2004
Archaeology	2006	Fingerprinting	2003	Public Health	2005
Archery	2004	Fire Safety	2004	Public Speaking	2002
Architecture	2008	First Aid	2007	Pulp and Paper	2006
Art	2004	Fish and Wildlife	2004	Radio	2008
Astronomy	2004	Management	2004	Railroading	2003
Athletics	2006	Fishing	2009	Reading	2003
Automotive Maintenance	2008	Fly-Fishing	2009	Reptile and Amphibian Study	2005
Aviation	2006	Forestry	2005	Rifle Shooting	2001
Backpacking	2007	Gardening	2002	Rowing	2006
Bakery	2003	Genealogy	2005	Safety	2006
Bugling (see Music)	2005	Geology	2005	Salesmanship	2003
Camping	2005	Golf	2002	Scholarship	2004
Canoing	2004	Hiking	2007	Scuba Diving	2009
Chemistry	2004	Home Repairs	2009	Sculpture	2007
Cinematography	2008	Horsemanship	2003	Shooting	2005
Citizenship in the Community	2005	Indian Lore	2008	Skating	2005
Citizenship in the Nation	2005	Insect Study	2008	Snow Sports	2004
Citizenship in the World	2005	Journalism	2006	Small-Boat Sailing	2007
Climbing	2006	Landscaping	2008	Soil and Water Conservation	2004
Coin Collecting	2008	Leatherwork	2002	Space Exploration	2004
Collections	2008	Lifesaving	2008	Sports	2006
Communication	2009	Mammal Study	2003	Stamp Collecting	2007
Composite Materials	2006	Medicine	2009	Surveying	2004
Computers	2009	Metalwork	2007	Swimming	2008
Cooking	2007	Modal Design and Building	2003	Textile	2003
Crime Prevention	2005	Motorboating	2008	Theater	2005
Cycling	2003	Music and Bugling	2003	Traffic Safety	2006
Dentistry	2006	Nature	2003	Truck Transportation	2005
Disabilities Awareness	2005	Nuclear Science	2004	Veterinary Medicine	2005
Dog Care	2003	Oceanography	2009	Water Sports	2007
Drafting	2008	Orienteering	2003	Weather	2006
Electricity	2004	Painting	2008	Whitewater	2005
Electronics	2004	Personal Fitness	2006	Wilderness Survival	2007
Emergency Preparedness	2008	Personal Management	2003	Wood Carving	2006
Energy	2005	Pets	2003	Woodwork	2003

## BOY SCOUTS OF AMERICA • SUPPLY GROUP

**NATIONAL DISTRIBUTION CENTER**  
2109 Westinghouse Boulevard  
P.O. Box 7143  
Charlotte, NC 28241-7143

**DIRECT MAIL CENTER**  
P.O. Box 909  
Pineville, NC 28134-0909

For fast credit card orders—  
call BSA operators toll-free  
1-800-323-0732

[www.scoutstuff.org](http://www.scoutstuff.org)